

# GE08MPS06A

## 650V 8A SiC Schottky MPS™ Diode



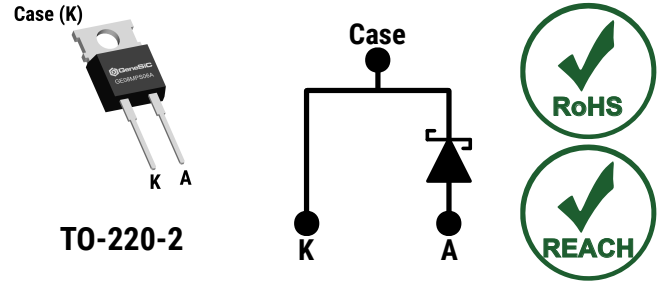
### Silicon Carbide Schottky Diode

$V_{RRM}$	=	650 V
$I_F (T_C = 151^\circ\text{C})$	=	8 A
$Q_C$	=	20 nC

#### Features

- Gen5 Thin Chip Technology for Low  $V_F$
- Low Conduction Losses for All Load Conditions
- Superior Figure of Merit  $Q_C/I_F$
- Enhanced Surge Current Robustness
- Low Thermal Resistance
- Temperature Independent Fast Switching
- Positive Temperature Coefficient of  $V_F$
- High  $dV/dt$  Ruggedness

#### Package



#### Advantages

- Optimal Price Performance
- Improved System Efficiency
- Enables Extremely Fast Switching
- Reduced Cooling Requirements
- Increased System Power Density
- Zero Reverse Recovery Current
- Easy to Parallel without Thermal Runaway
- High System Reliability

#### Applications

- Switched Mode Power Supply (SMPS)
- Solar Inverter
- Server and Telecom Power Supply
- Battery Charger
- Uninterruptible Power Supply (UPS)
- Motor Control
- Power Factor Correction (PFC)

#### Absolute Maximum Ratings (At $T_C = 25^\circ\text{C}$ Unless Otherwise Stated)

Parameter	Symbol	Conditions	Values	Unit	Note
Repetitive Peak Reverse Voltage	$V_{RRM}$		650	V	
Continuous Forward Current	$I_F$	$T_C = 100^\circ\text{C}, D = 1$	15		Fig. 4
		$T_C = 135^\circ\text{C}, D = 1$	11	A	
		$T_C = 151^\circ\text{C}, D = 1$	8		
Non-Repetitive Peak Forward Surge Current, Half Sine Wave	$I_{F,SM}$	$T_C = 25^\circ\text{C}, t_P = 10 \text{ ms}$	44	A	
		$T_C = 150^\circ\text{C}, t_P = 10 \text{ ms}$	36		
Repetitive Peak Forward Surge Current, Half Sine Wave	$I_{F,RM}$	$T_C = 25^\circ\text{C}, t_P = 10 \text{ ms}$	27	A	
		$T_C = 150^\circ\text{C}, t_P = 10 \text{ ms}$	19		
Non-Repetitive Peak Forward Surge Current	$I_{F,MAX}$	$T_C = 25^\circ\text{C}, t_P = 10 \mu\text{s}$	220	A	
$i^2t$ Value	$\int i^2 dt$	$T_C = 25^\circ\text{C}, t_P = 10 \text{ ms}$	9.68	$\text{A}^2\text{s}$	
Non-Repetitive Avalanche Energy	$E_{AS}$	$L = 3.3 \text{ mH}, I_{AS} = 8 \text{ A}$	105	mJ	
Diode Ruggedness	$dV/dt$	$V_R = 0 \sim 520 \text{ V}$	200	V/ns	
Power Dissipation	$P_{TOT}$	$T_C = 25^\circ\text{C}$	87	W	Fig. 3
Operating and Storage Temperature	$T_j, T_{stg}$		-55 to 175	$^\circ\text{C}$	

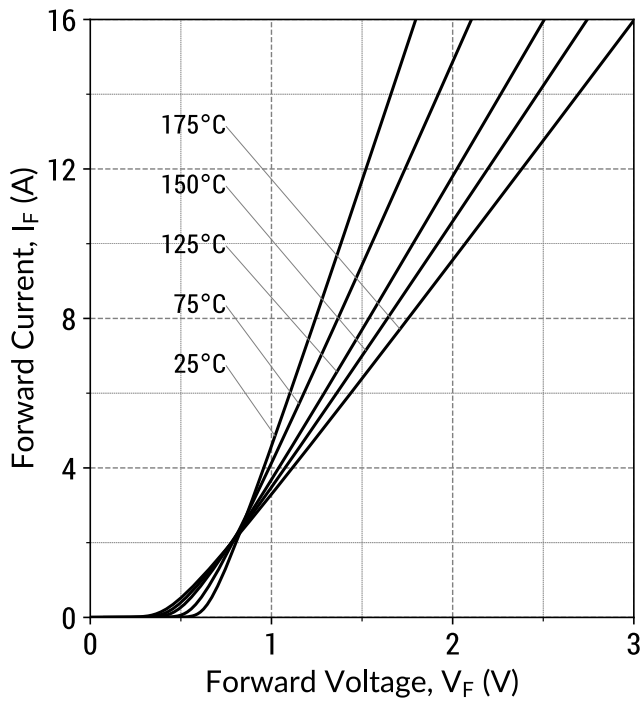
### Electrical Characteristics

Parameter	Symbol	Conditions	Values			Unit	Note
			Min.	Typ.	Max.		
Diode Forward Voltage	$V_F$	$I_F = 8\text{ A}, T_j = 25^\circ\text{C}$		1.25	1.35	V	Fig. 1
		$I_F = 8\text{ A}, T_j = 150^\circ\text{C}$		1.64			
Reverse Current	$I_R$	$V_R = 650\text{ V}, T_j = 25^\circ\text{C}$		1	5	$\mu\text{A}$	Fig. 2
		$V_R = 650\text{ V}, T_j = 150^\circ\text{C}$		56			
Total Capacitive Charge	$Q_C$	$I_F \leq I_{F,MAX}$ $di_F/dt = 200\text{ A}/\mu\text{s}$	$V_R = 200\text{ V}$	14		nC	Fig. 7
			$V_R = 400\text{ V}$	20			
Switching Time	$t_s$	$di_F/dt = 200\text{ A}/\mu\text{s}$	$V_R = 200\text{ V}$	< 10		ns	
			$V_R = 400\text{ V}$				
Total Capacitance	C	$V_R = 1\text{ V}, f = 1\text{ MHz}$		373		pF	Fig. 6
		$V_R = 400\text{ V}, f = 1\text{ MHz}$		26			

### Thermal/Package Characteristics

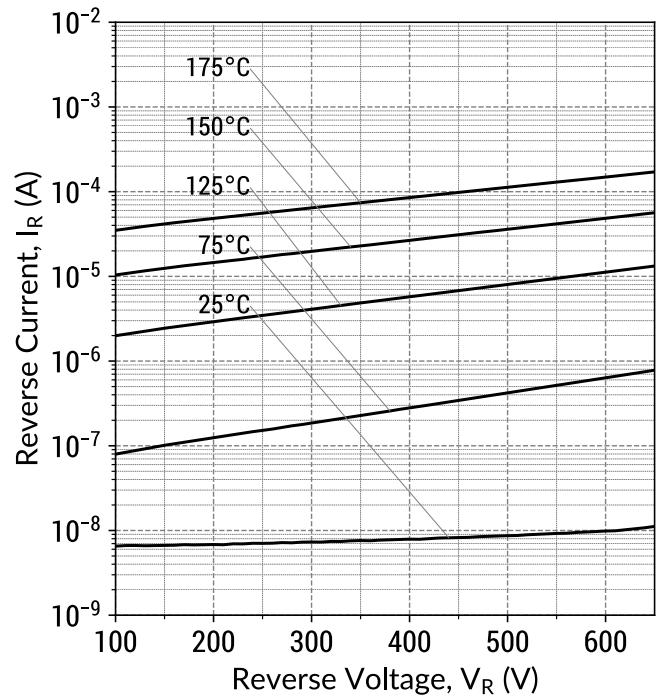
Parameter	Symbol	Conditions	Values			Unit	Note
			Min.	Typ.	Max.		
Thermal Resistance, Junction - Case	$R_{thJC}$			1.72		$^\circ\text{C}/\text{W}$	Fig. 9
Weight	$W_T$			2.0		g	
Mounting Torque	$T_M$	Screws to Heatsink			1.0	Nm	

Figure 1: Typical Forward Characteristics



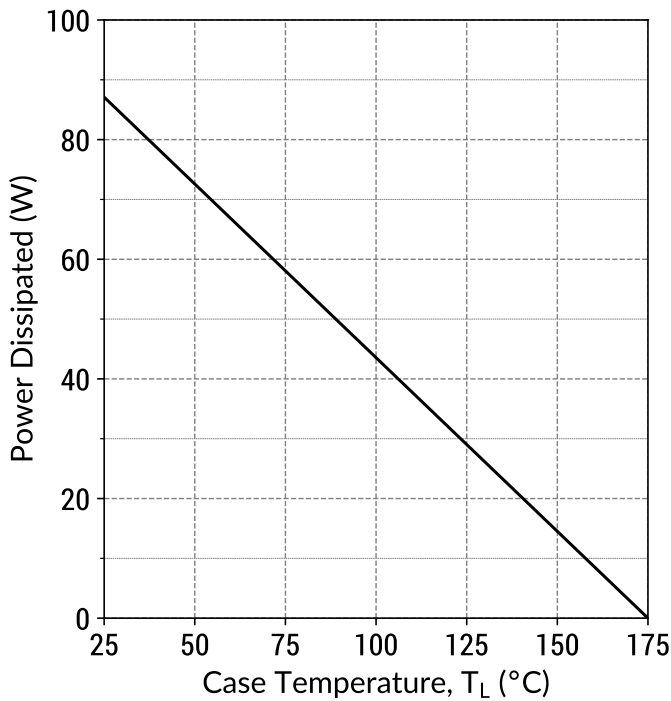
$$I_F = f(V_F, T_j); t_P = 250 \mu s$$

Figure 2: Typical Reverse Characteristics



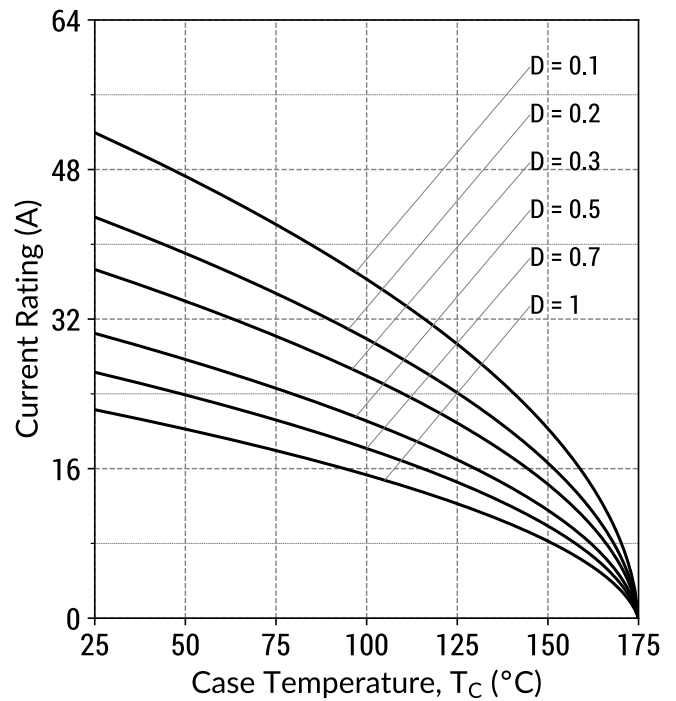
$$I_R = f(V_R, T_j)$$

Figure 3: Power Derating Curves



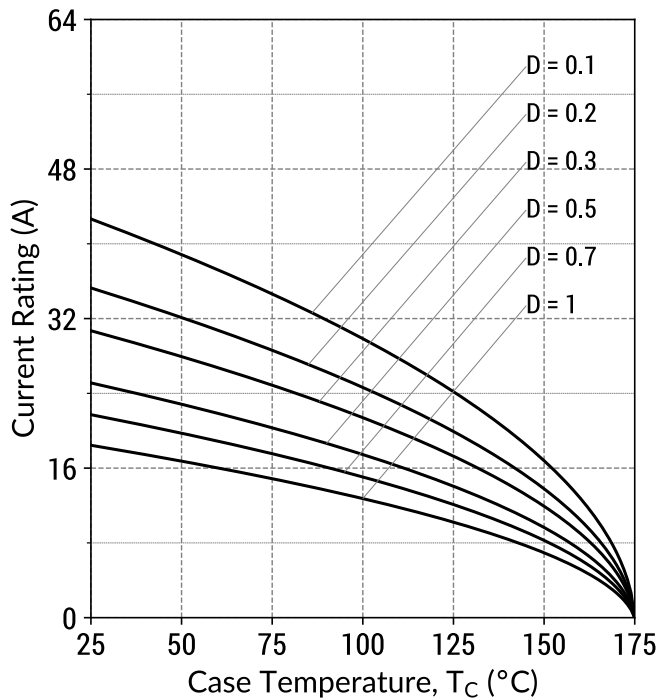
$$P_{TOT} = f(T_C); T_j = 175^\circ C$$

Figure 4: Current Derating Curves (Typical  $V_F$ )



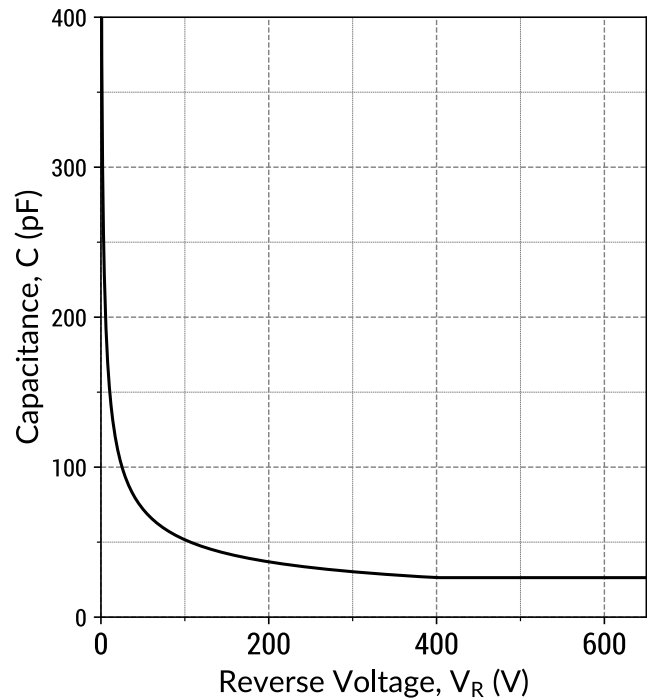
$$I_F = f(T_C); D = t_P/T; T_j \leq 175^\circ C; f_{sw} > 10kHz$$

**Figure 5: Current Derating Curves (Maximum  $V_F$ )**



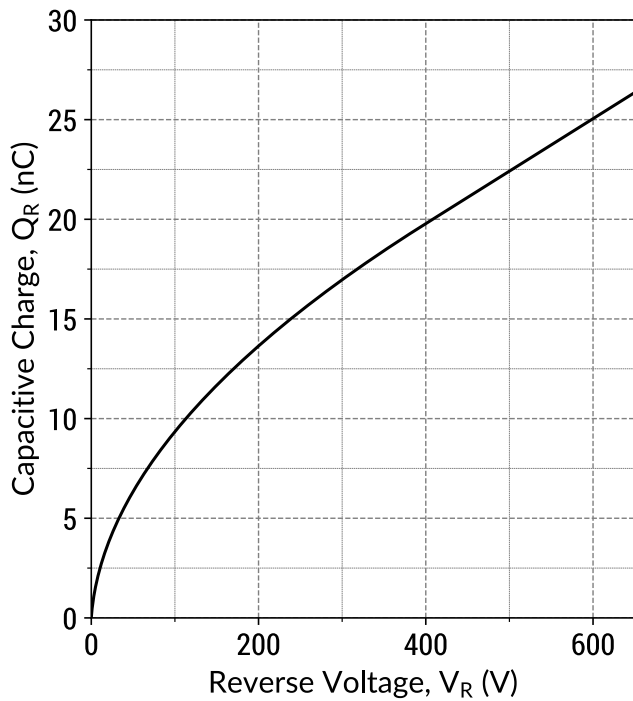
$I_F = f(T_C)$ ;  $D = t_P/T$ ;  $T_J \leq 175^\circ\text{C}$ ;  $f_{SW} > 10\text{kHz}$

**Figure 6: Typical Junction Capacitance vs Reverse Voltage Characteristics**



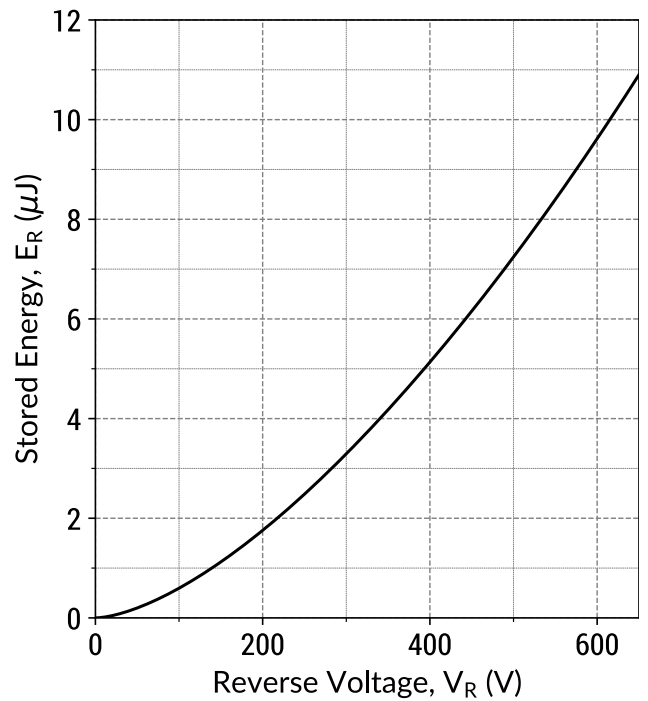
$C = f(V_R)$ ;  $f = 1\text{MHz}$

**Figure 7: Typical Capacitive Charge vs Reverse Voltage Characteristics**



$Q_C = f(V_R)$ ;  $f = 1\text{MHz}$

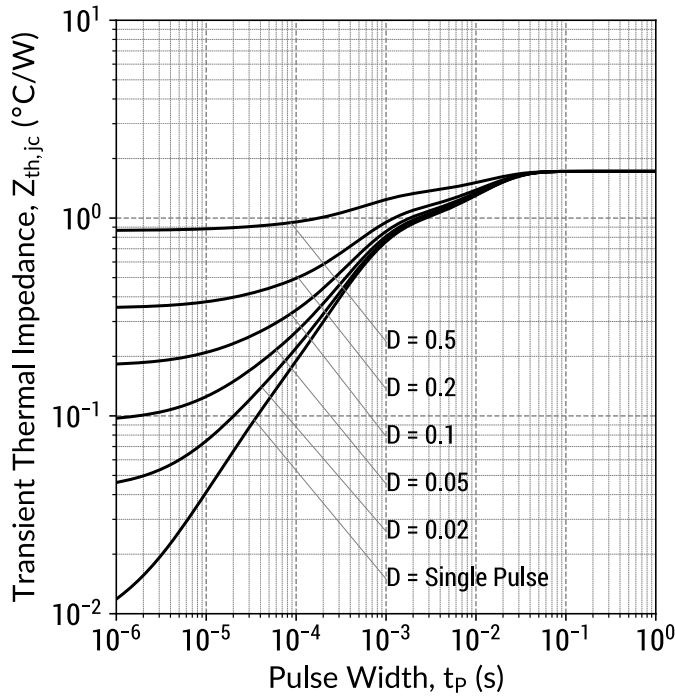
**Figure 8: Typical Capacitive Energy vs Reverse Voltage Characteristics**



$E_C = f(V_R)$ ;  $f = 1\text{MHz}$

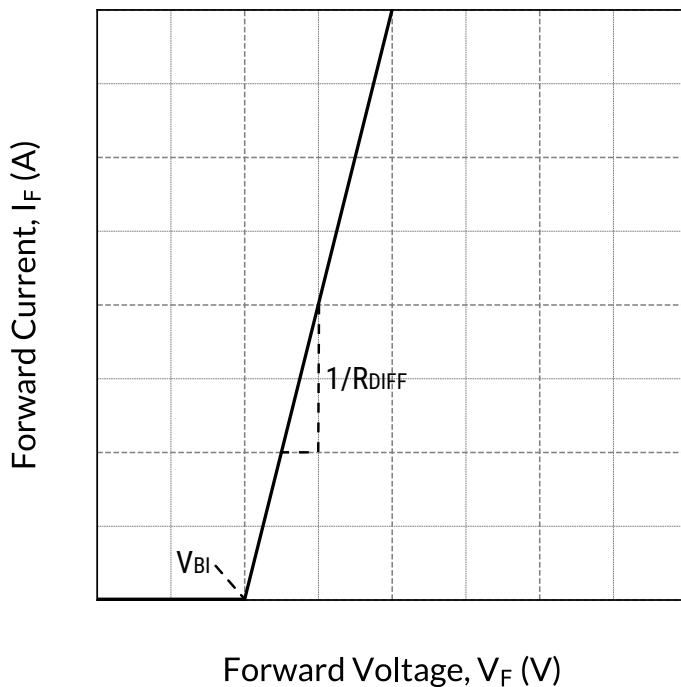


Figure 9: Transient Thermal Impedance



$$Z_{th,jc} = f(t_p, D); D = t_p/T$$

Figure 10: Forward Curve Model



$$I_F = f(V_F, T_j)$$

Forward Curve Model Equation:

$$I_F = (V_F - V_{BI})/R_{DIFF} \text{ (A)}$$

Built-In Voltage ( $V_{BI}$ ):

$$V_{BI}(T_j) = m \times T_j + n \text{ (V)}$$

$$m = -0.00124 \text{ (V/°C)}$$

$$n = 0.72 \text{ (V)}$$

Differential Resistance ( $R_{DIFF}$ ):

$$R_{DIFF}(T_j) = a \times T_j^2 + b \times T_j + c \text{ (}\Omega\text{)}$$

$$a = 1.2e-06 \text{ (}\Omega\text{/°C}^2\text{)}$$

$$b = 0.000341 \text{ (}\Omega\text{/°C)}$$

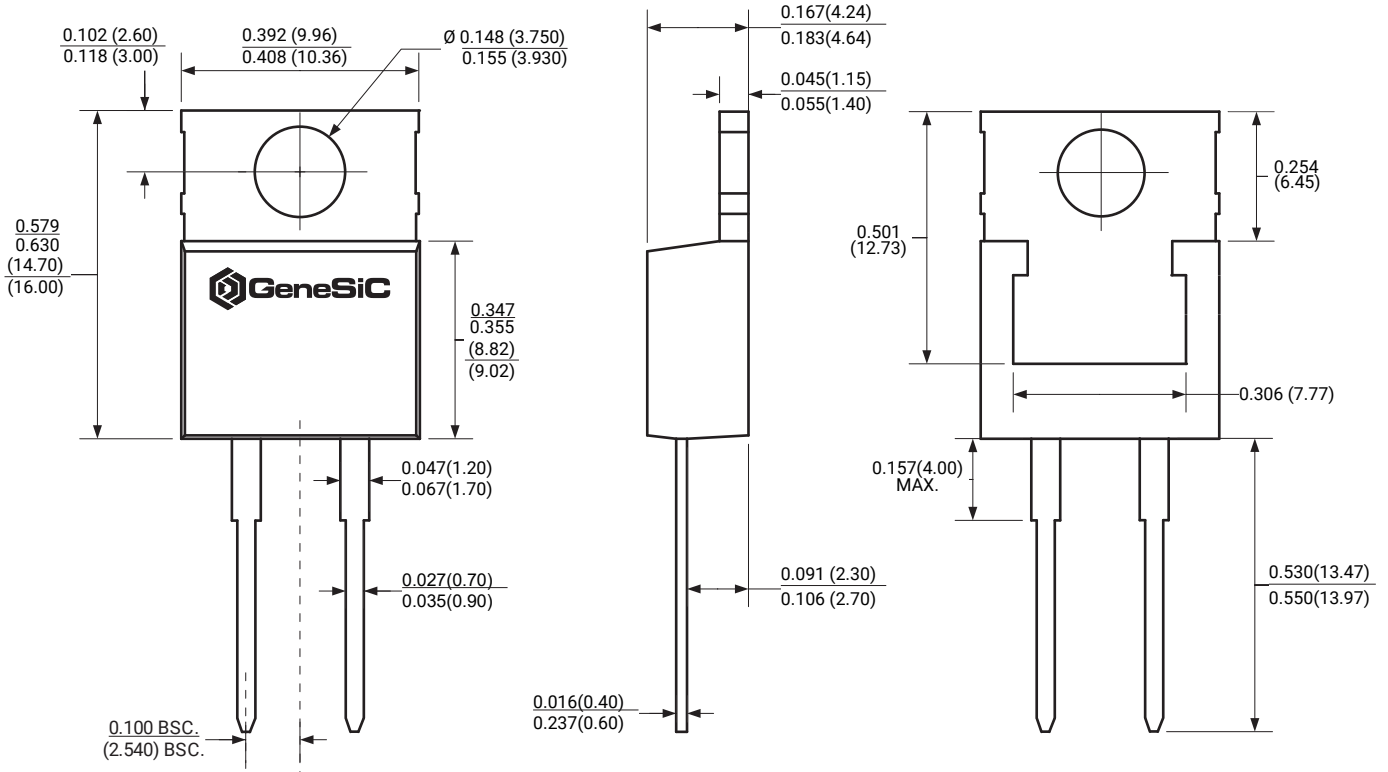
$$c = 0.0602 \text{ (}\Omega\text{)}$$

Forward Power Loss Equation:

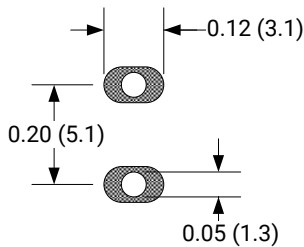
$$P_{LOSS} = V_{BI}(T_j) \times I_{AVG} + R_{DIFF}(T_j) \times I_{RMS}^2$$

Package Dimensions

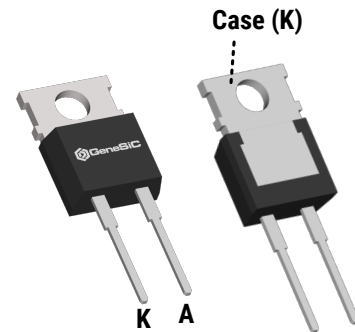
TO-220-2 Package Outline



Recommended Solder Pad Layout



Package View



NOTE

1. CONTROLLED DIMENSION IS INCH. DIMENSION IN BRACKET IS MILLIMETER.
2. DIMENSIONS DO NOT INCLUDE END FLASH, MOLD FLASH, MATERIAL PROTRUSIONS.

## Compliance

### RoHS Compliance

The levels of RoHS restricted materials in this product are below the maximum concentration values (also referred to as the threshold limits) permitted for such substances, or are used in an exempted application, in accordance with EU Directive 2011/65/EC (RoHS 2), as adopted by EU member states on January 2, 2013 and amended on March 31, 2015 by EU Directive 2015/863. RoHS Declarations for this product can be obtained from your GeneSiC representative.

### REACH Compliance

REACH substances of high concern (SVHCs) information is available for this product. Since the European Chemical Agency (ECHA) has published notice of their intent to frequently revise the SVHC listing for the foreseeable future, please contact a GeneSiC representative to insure you get the most up-to-date REACH SVHC Declaration. REACH banned substance information (REACH Article 67) is also available upon request.

## Disclaimer

GeneSiC Semiconductor, Inc. reserves right to make changes to the product specifications and data in this document without notice. GeneSiC disclaims all and any warranty and liability arising out of use or application of any product. No license, express or implied to any intellectual property rights is granted by this document.

Unless otherwise expressly indicated, GeneSiC products are not designed, tested or authorized for use in life-saving, medical, aircraft navigation, communication, air traffic control and weapons systems, nor in applications where their failure may result in death, personal injury and/or property damage.

## Related Links

- SPICE Models: [https://www.genesicsemi.com/sic-schottky-mps/GE08MPS06A/GE08MPS06A\\_SPICE.zip](https://www.genesicsemi.com/sic-schottky-mps/GE08MPS06A/GE08MPS06A_SPICE.zip)
- PLECS Models: [https://www.genesicsemi.com/sic-schottky-mps/GE08MPS06A/GE08MPS06A\\_PLECS.zip](https://www.genesicsemi.com/sic-schottky-mps/GE08MPS06A/GE08MPS06A_PLECS.zip)
- CAD Models: [https://www.genesicsemi.com/sic-schottky-mps/GE08MPS06A/GE08MPS06A\\_3D.zip](https://www.genesicsemi.com/sic-schottky-mps/GE08MPS06A/GE08MPS06A_3D.zip)
- Evaluation Boards: <https://www.genesicsemi.com/technical-support>
- Reliability: <https://www.genesicsemi.com/reliability>
- Compliance: <https://www.genesicsemi.com/compliance>
- Quality Manual: <https://www.genesicsemi.com/quality>

## Revision History

Date	Revision	Comments	Supersedes
Jul. 27, 2020	Rev 1	Initial Release	



[www.genesicsemi.com/sic-schottky-mps/](https://www.genesicsemi.com/sic-schottky-mps/)