

G2R50MT33-CAL

3300 V 50 mΩ SiC MOSFET



Silicon Carbide MOSFET
N-Channel Enhancement Mode

V_{DS}	=	3300 V
$R_{DS(ON)(Typ.)}$	=	50 mΩ
$I_D(T_C = 100^\circ C)$	=	50 A

Features

- G2R™ Technology with +20 V Gate Drive
- Superior $Q_G \times R_{DS(ON)}$ Figure of Merit
- Superior Cost-Performance Index
- Low Capacitances and Low Gate Charge
- Fast and Reliable Body Diode
- Low Losses at All Temperatures
- Excellent Avalanche and Short Circuit Robustness

Bare Chip

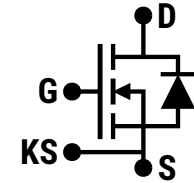
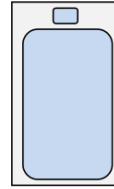

D = Drain
G = Gate
S = Source
KS = Kelvin Source

Advantages

- Ease of Use - Simple to Drive
- Increased Power Density for Compact System
- High Frequency Switching
- Improved Thermal Capability
- Ease of Paralleling without Thermal Runaway

Applications

- Traction
- Solar String Inverters
- EV- Fast Chargers
- Pulsed Power
- Switched Mode Power Supply
- Energy Storage
- Solid State Transformers
- Solid State Circuit Breakers

Absolute Maximum Ratings (At $T_C = 25^\circ C$ Unless Otherwise Stated)

Parameter	Symbol	Conditions	Values	Unit	Note
Drain-Source Voltage	$V_{DS(max)}$	$V_{GS} = 0 V, I_D = 100 \mu A$	3300	V	
Gate-Source Voltage (Dynamic)	$V_{GS(max)}$		-10 / +25	V	
Gate-Source Voltage (Static)	$V_{GS(op)}$	Recommended Operation	-5 / +20	V	
Continuous Forward Current	I_D	$T_C = 25^\circ C, V_{GS} = -5 / +20 V$	70	A	
		$T_C = 100^\circ C, V_{GS} = -5 / +20 V$	50		
		$T_C = 135^\circ C, V_{GS} = -5 / +20 V$	36		
Pulsed Drain Current	$I_{D(pulse)}$	$t_P \leq 3 \mu s, D \leq 1\%, V_{GS} = 20 V, \text{Note 1}$	235	A	
Power Dissipation	P_D	$T_C = 25^\circ C$	647	W	Note 2
Non-Repetitive Avalanche Energy	E_{AS}	$L = 11.2 mH, I_{AS} = 20.0 A$	2250	mJ	
Operating and Storage Temperature	T_j, T_{stg}		-55 to 175	$^\circ C$	

Note 1: Pulse Width t_P Limited by $T_{j(max)}$

Note 2: Assuming $R_{thJC(max)} = 0.23^\circ C/W$

Electrical Characteristics (At $T_C = 25^\circ\text{C}$ Unless Otherwise Stated)

Parameter	Symbol	Conditions	Values			Unit	Note
			Min.	Typ.	Max.		
Drain-Source Breakdown Voltage	V_{DSS}	$V_{GS} = 0\text{ V}, I_D = 100\ \mu\text{A}$	3300			V	
Zero Gate Voltage Drain Current	I_{DSS}	$V_{DS} = 3300\text{ V}, V_{GS} = 0\text{ V}$		1		μA	
Gate Source Leakage Current	I_{GSS}	$V_{DS} = 0\text{ V}, V_{GS} = 25\text{ V}$			100	nA	
		$V_{DS} = 0\text{ V}, V_{GS} = -10\text{ V}$			-100		
Gate Threshold Voltage	$V_{GS(th)}$	$V_{DS} = V_{GS}, I_D = 10.0\text{ mA}$	2.5	3.50		V	Fig. 9
		$V_{DS} = V_{GS}, I_D = 10.0\text{ mA}, T_j = 175^\circ\text{C}$		2.40			
Transconductance	g_{fs}	$V_{DS} = 10\text{ V}, I_D = 40\text{ A}$		14.7		S	Fig. 4
		$V_{DS} = 10\text{ V}, I_D = 40\text{ A}, T_j = 175^\circ\text{C}$		15.6			
Drain-Source On-State Resistance	$R_{DS(on)}$	$V_{GS} = 20\text{ V}, I_D = 40\text{ A}$		50	65	$\text{m}\Omega$	Fig. 5-8
		$V_{GS} = 20\text{ V}, I_D = 40\text{ A}, T_j = 175^\circ\text{C}$		101			
Input Capacitance	C_{iss}			7301		pF	Fig. 11
Output Capacitance	C_{oss}			130			
Reverse Transfer Capacitance	C_{rss}	$V_{DS} = 1000\text{ V}, V_{GS} = 0\text{ V}$ $f = 1\text{ MHz}, V_{AC} = 25\text{ mV}$		12.3		μJ	Fig. 12
C_{oss} Stored Energy	E_{oss}			84			
C_{oss} Stored Charge	Q_{oss}			254		nC	
Gate-Source Charge	Q_{gs}	$V_{DS} = 1000\text{ V}, V_{GS} = -5 / +20\text{ V}$		120		nC	Fig. 10
Gate-Drain Charge	Q_{gd}	$I_D = 40\text{ A}$		100			
Total Gate Charge	Q_g	Per IEC607478-4		340			
Internal Gate Resistance	$R_{G(int)}$	$f = 1\text{ MHz}, V_{AC} = 25\text{ mV}$		1.2		Ω	
Turn-On Switching Energy (Body Diode)	E_{on}	$T_j = 25^\circ\text{C}; V_{GS} = -5/+20\text{V}; R_{G(ext)} = 8\ \Omega, I_D = 50\text{ A}; V_{DD} = 1700\text{ V}$		1641		μJ	Fig. 18
Turn-Off Switching Energy (Body Diode)	E_{off}			1075			
Turn-On Delay Time	$t_{d(on)}$			85		ns	Fig. 20
Rise Time	t_r	$V_{DD} = 1700\text{ V}, V_{GS} = -5/+20\text{V}$ $R_{G(ext)} = 8\ \Omega, I_D = 50\text{ A}$		190			
Turn-Off Delay Time	$t_{d(off)}$	Timing relative to V_{DS} , Resistive load		70			
Fall Time	t_f			118			

Reverse Diode Characteristics

Parameter	Symbol	Conditions	Values			Unit	Note
			Min.	Typ.	Max.		
Diode Forward Voltage	V_{SD}	$V_{GS} = -5\text{ V}, I_{SD} = 20\text{ A}$		4.1		V	Fig. 13-14
		$V_{GS} = -5\text{ V}, I_{SD} = 20\text{ A}, T_j = 175^\circ\text{C}$		3.5			
Continuous Diode Forward Current	I_S	$V_{GS} = -5\text{ V}, T_C = 100^\circ\text{C}$	56			A	
Diode Pulse Current	$I_{S(pulse)}$	$V_{GS} = -5\text{ V}, \text{Note 1}$		224		A	
Reverse Recovery Time	t_{rr}			154		ns	
Reverse Recovery Charge	Q_{rr}	$V_{GS} = -5\text{ V}, I_{SD} = 50\text{ A}, V_R = 1700\text{ V}$ $dif/dt = 500\text{ A}/\mu\text{s}, T_j = 25^\circ\text{C}$		740		nC	
Peak Reverse Recovery Current	I_{rrm}			17		A	
Reverse Recovery Time	t_{rr}			204		ns	
Reverse Recovery Charge	Q_{rr}	$V_{GS} = -5\text{ V}, I_{SD} = 50\text{ A}, V_R = 1700\text{ V}$ $dif/dt = 500\text{ A}/\mu\text{s}, T_j = 175^\circ\text{C}$		2840		nC	
Peak Reverse Recovery Current	I_{rrm}			38		A	

*The chip technology was characterized up to 200 V/ns. The measured dV/dt was limited by measurement test setup and package.

Figure 1: Output Characteristics ($T_j = 25^\circ\text{C}$)

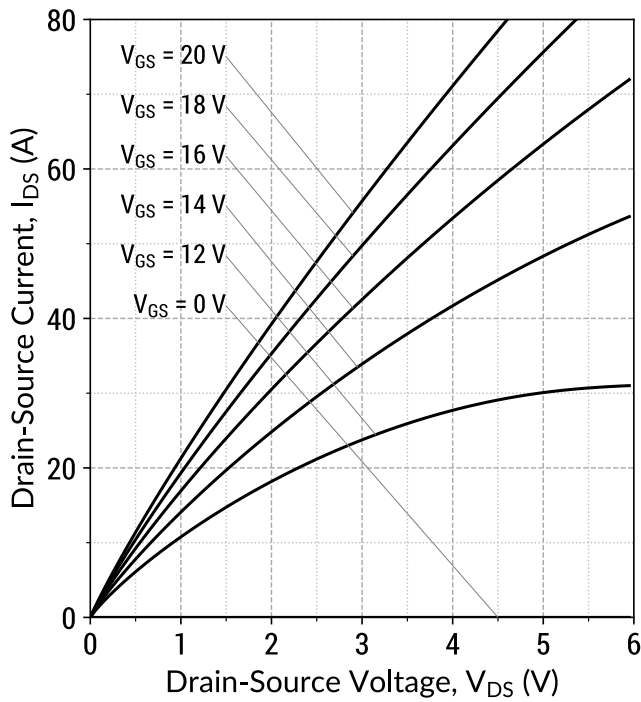

$$I_D = f(V_{DS}, V_{GS}); t_P = 250 \mu\text{s}$$

Figure 2: Output Characteristics ($T_j = 175^\circ\text{C}$)

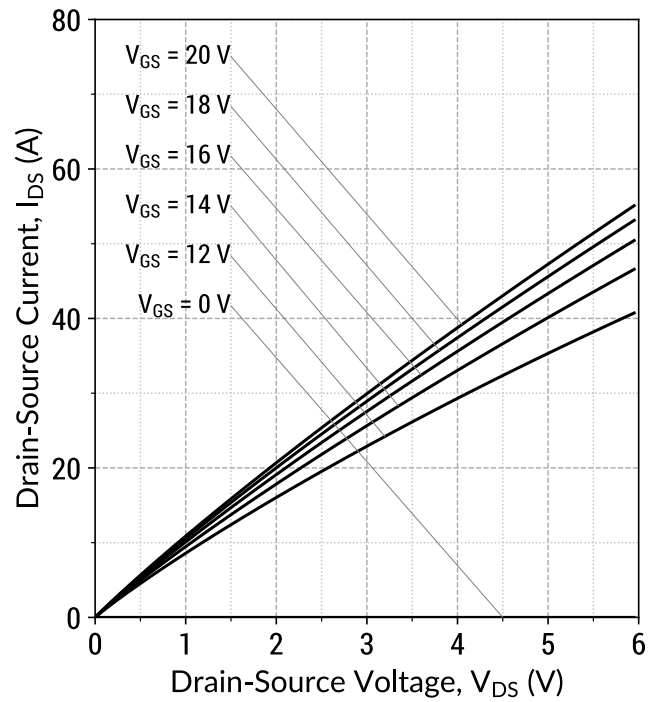

$$I_D = f(V_{DS}, V_{GS}); t_P = 250 \mu\text{s}$$

Figure 3: Output Characteristics ($V_{GS} = 20\text{ V}$)

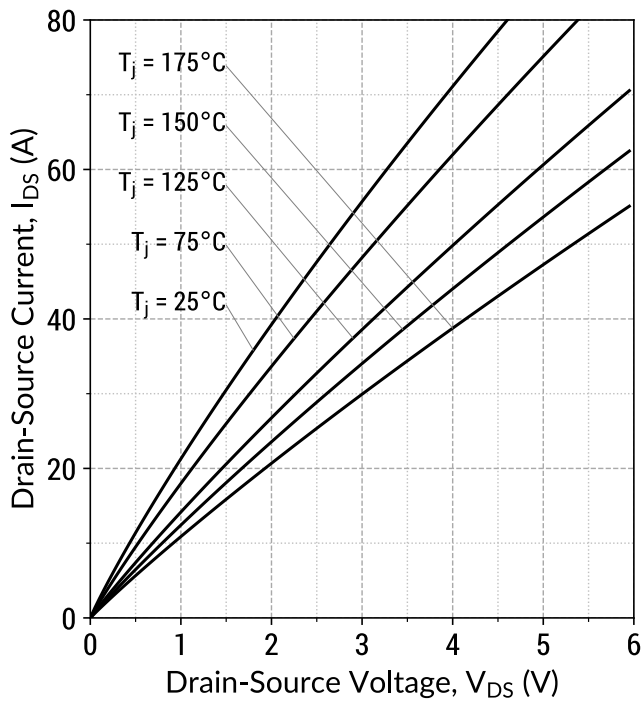

$$I_D = f(V_{DS}, T_j); t_P = 250 \mu\text{s}$$

Figure 4: Transfer Characteristics ($V_{DS} = 10\text{ V}$)

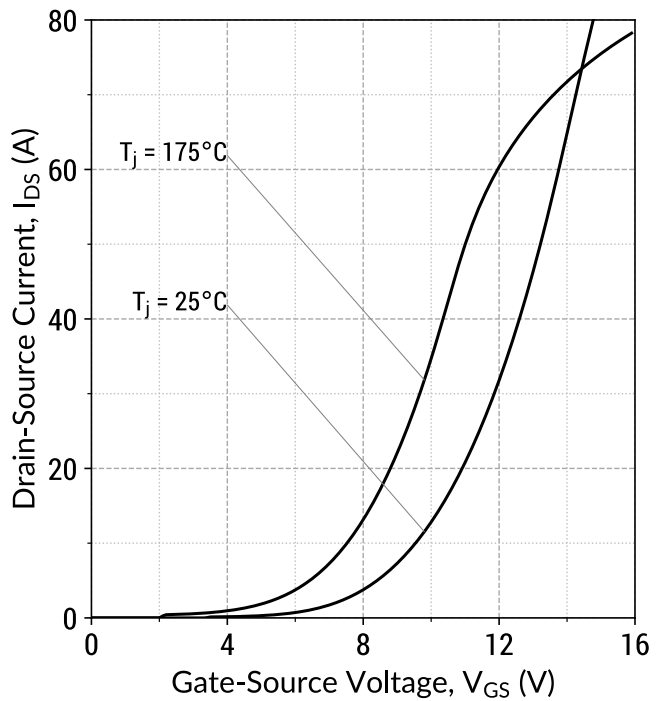

$$I_D = f(V_{GS}, T_j); t_P = 100 \mu\text{s}$$

Figure 5: On-State Resistance v/s Temperature

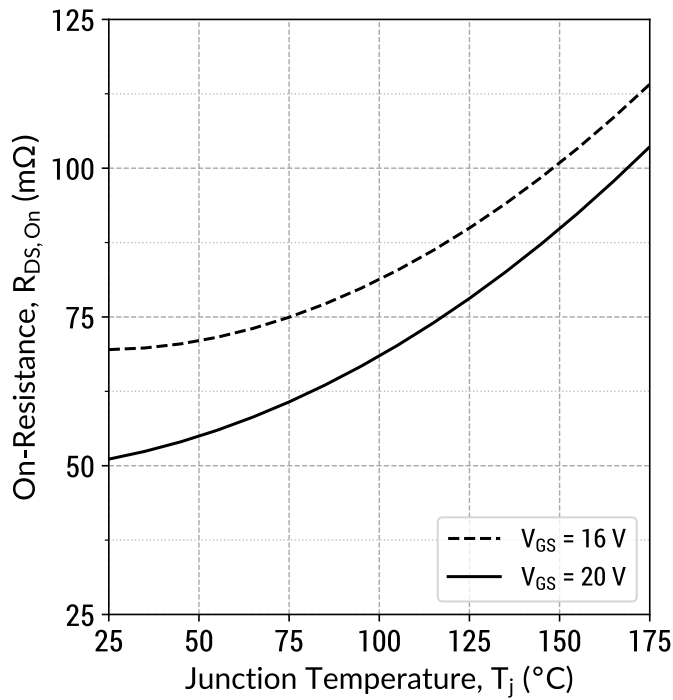

$R_{DS(on)} = f(T_j, V_{GS}); t_P = 250\ \mu\text{s}; I_D = 40\text{ A}$

Figure 6: On-State Resistance v/s Drain Current

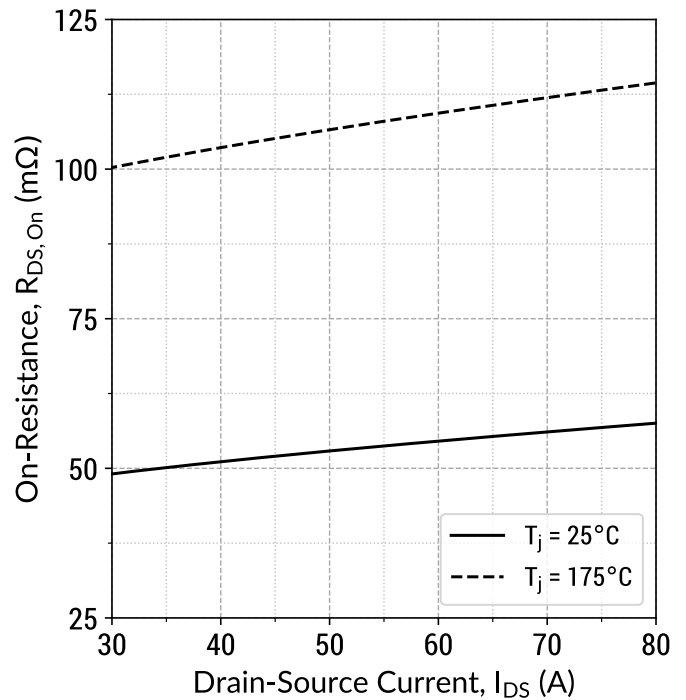

$R_{DS(on)} = f(T_j, I_D); t_P = 250\ \mu\text{s}; V_{GS} = 20\text{ V}$

Figure 7: Normalized On-State Resistance v/s Temperature

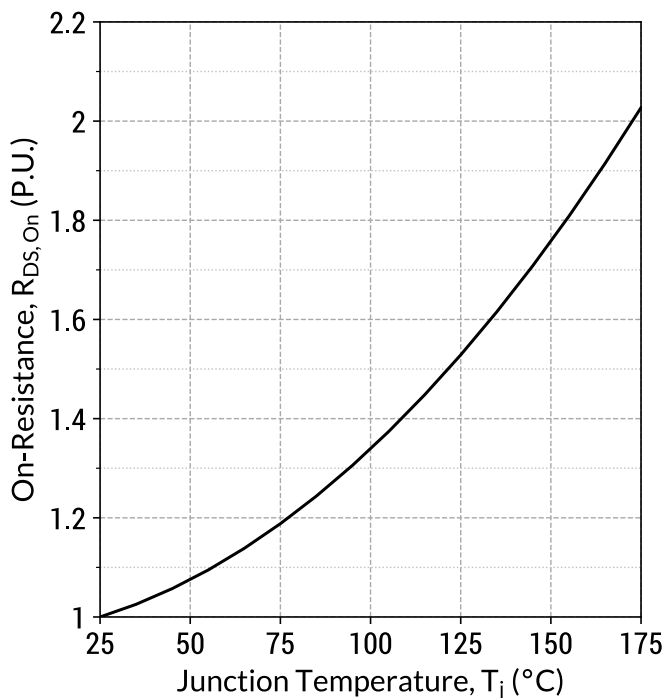

$R_{DS(on)} = f(T_j); t_P = 250\ \mu\text{s}; I_D = 40\text{ A}; V_{GS} = 20\text{ V}$

Figure 8: On-State Resistance v/s Gate Voltage

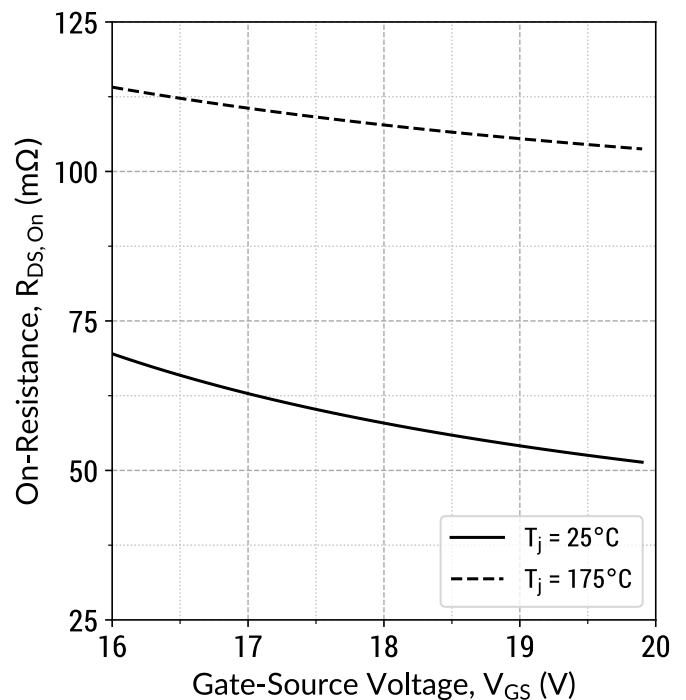

$R_{DS(on)} = f(T_j, V_{GS}); t_P = 250\ \mu\text{s}; I_D = 40\text{ A}$

Figure 9: Threshold Voltage Characteristics

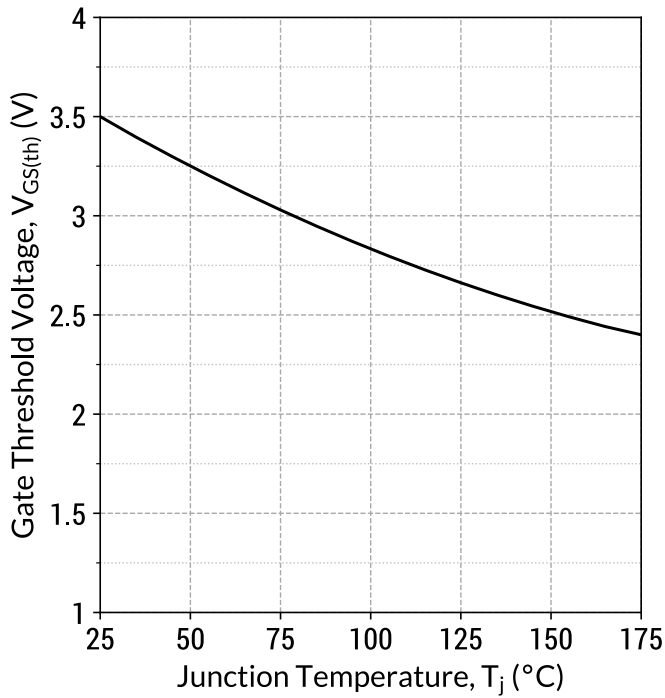

$V_{GS(th)} = f(T_j); V_{DS} = V_{GS}; I_D = 10.0 \text{ mA}$

Figure 10: Gate Charge Characteristics

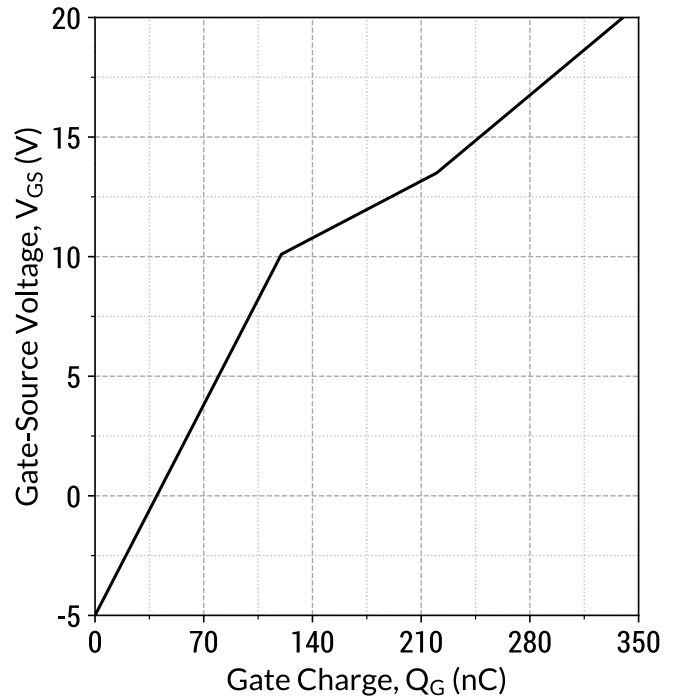

$I_D = 40 \text{ A}; V_{DS} = 1000 \text{ V}; T_C = 25^\circ\text{C}$

Figure 11: Capacitance v/s Drain-Source Voltage

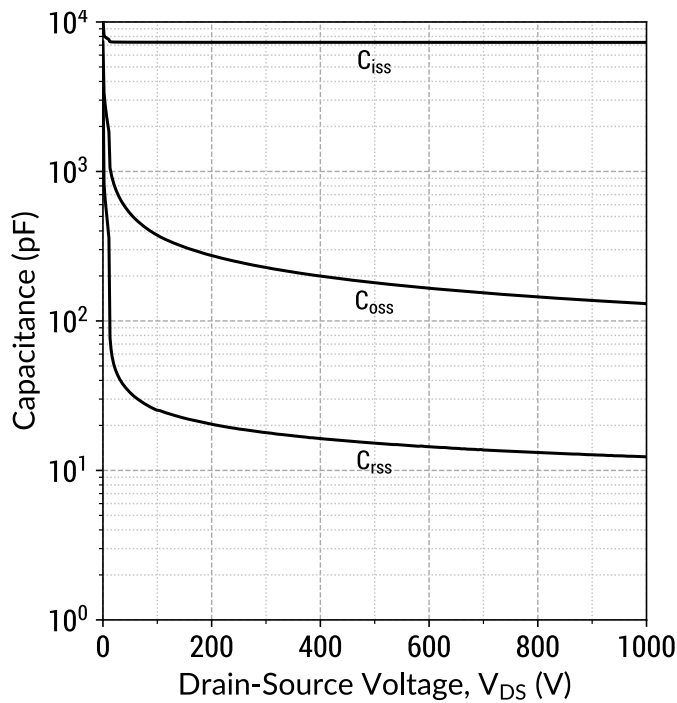

$f = 1 \text{ MHz}; V_{AC} = 25 \text{ mV}$

Figure 12: Output Capacitor Stored Energy

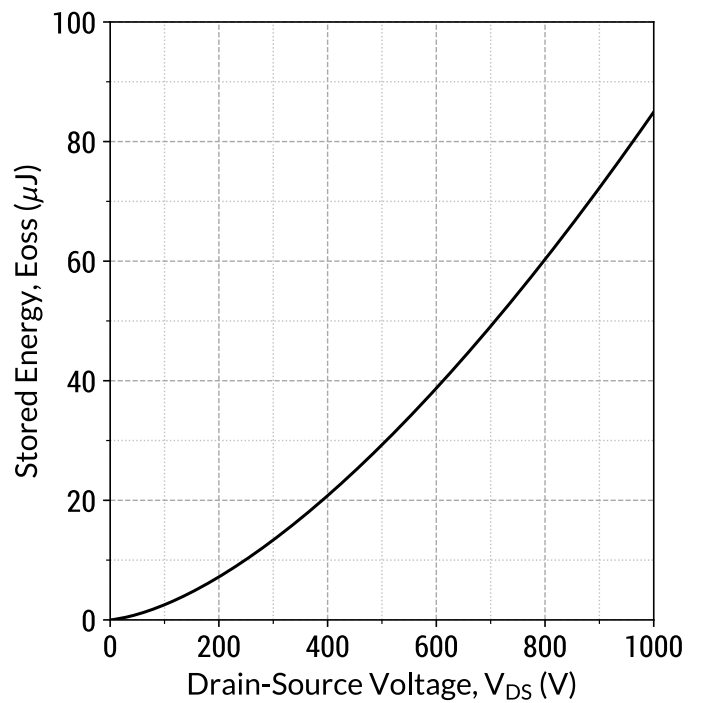

$E_{oss} = f(V_{DS})$

Figure 13: Body Diode Characteristics ($T_j = 25^\circ\text{C}$)

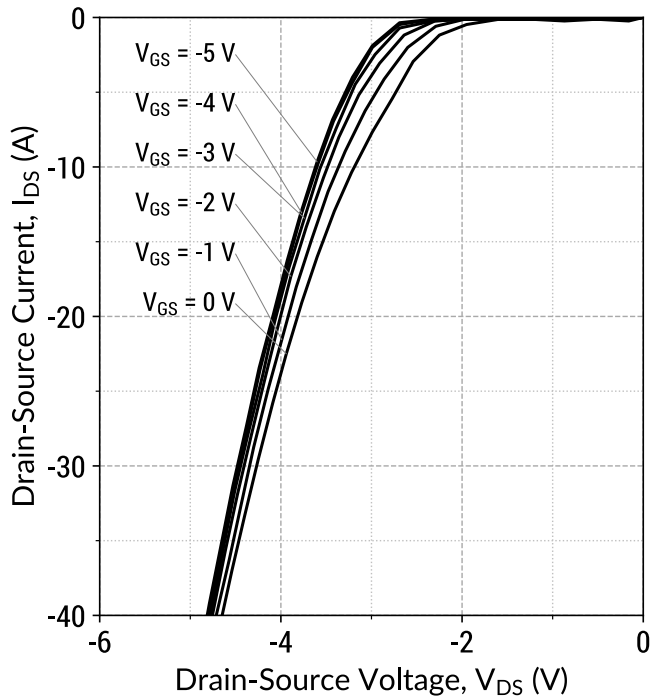

$$I_D = f(V_{DS}, V_{GS}); t_P = 250 \mu\text{s}$$

Figure 14: Body Diode Characteristics ($T_j = 175^\circ\text{C}$)

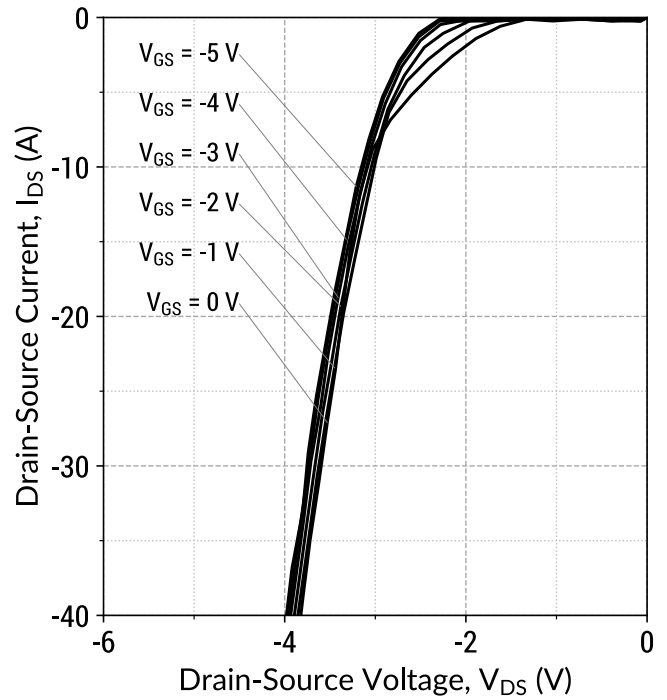

$$I_D = f(V_{DS}, V_{GS}); t_P = 250 \mu\text{s}$$

Figure 15: Third Quadrant Characteristics ($T_j = 25^\circ\text{C}$)

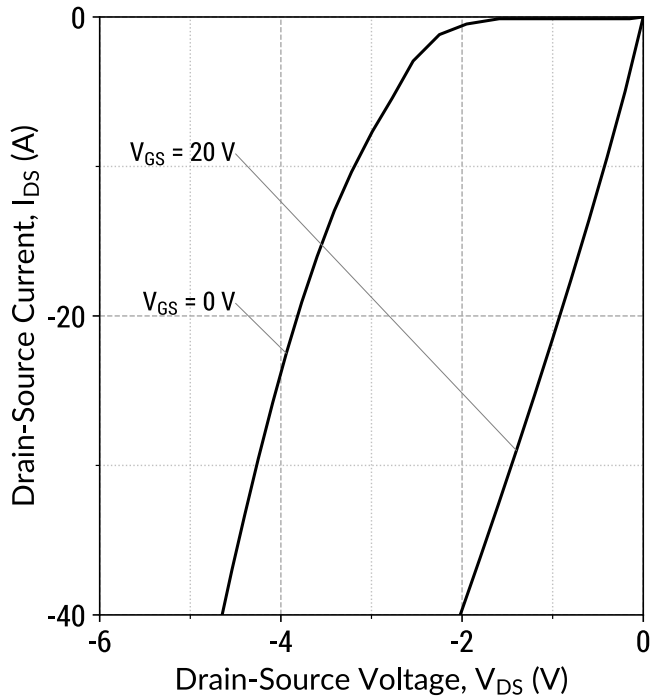

$$I_D = f(V_{DS}, V_{GS}); t_P = 250 \mu\text{s}$$

Figure 16: Third Quadrant Characteristics ($T_j = 175^\circ\text{C}$)

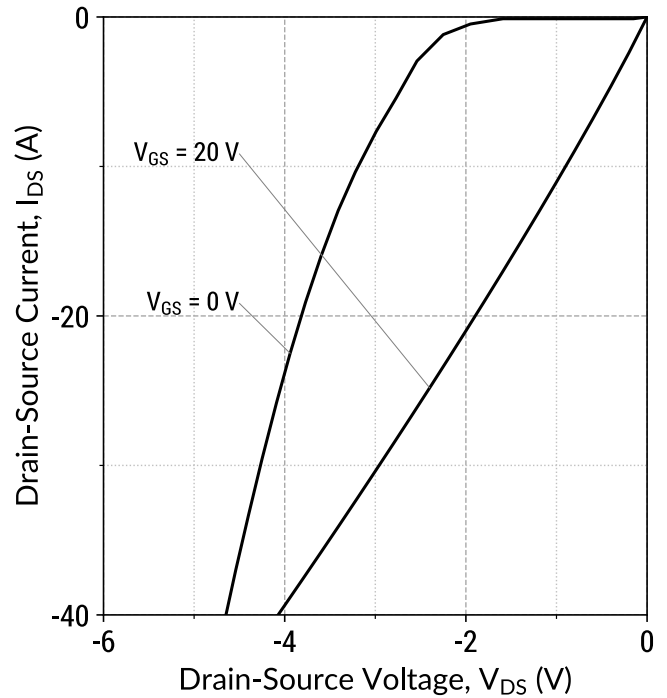

$$I_D = f(V_{DS}, V_{GS}); t_P = 250 \mu\text{s}$$

Figure 17: Resistive Switching Energy v/s Drain Current
($V_{DD} = 1500V$)

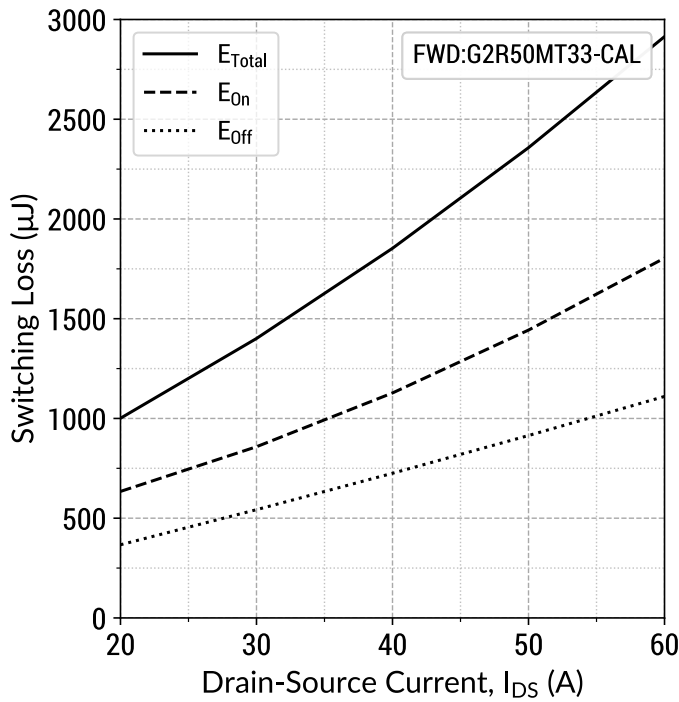

$T_j = 25^\circ C$; $V_{GS} = -5/+20V$; $R_{G(ext)} = 8 \Omega$

Figure 18: Resistive Switching Energy v/s Drain Current
($V_{DD} = 1700V$)

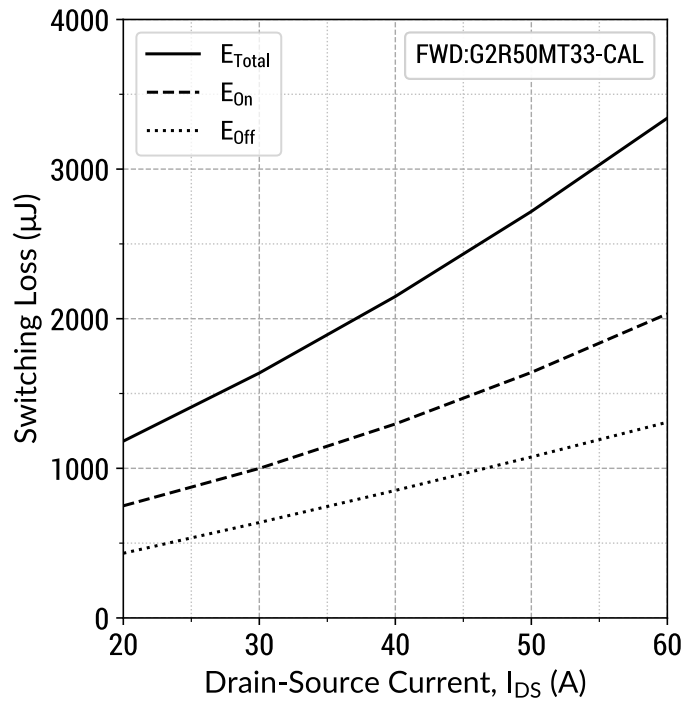

$T_j = 25^\circ C$; $V_{GS} = -5/+20V$; $R_{G(ext)} = 8 \Omega$

Figure 19: Resistive Switching Energy v/s $R_{G(ext)}$
($V_{DD} = 1700V$)

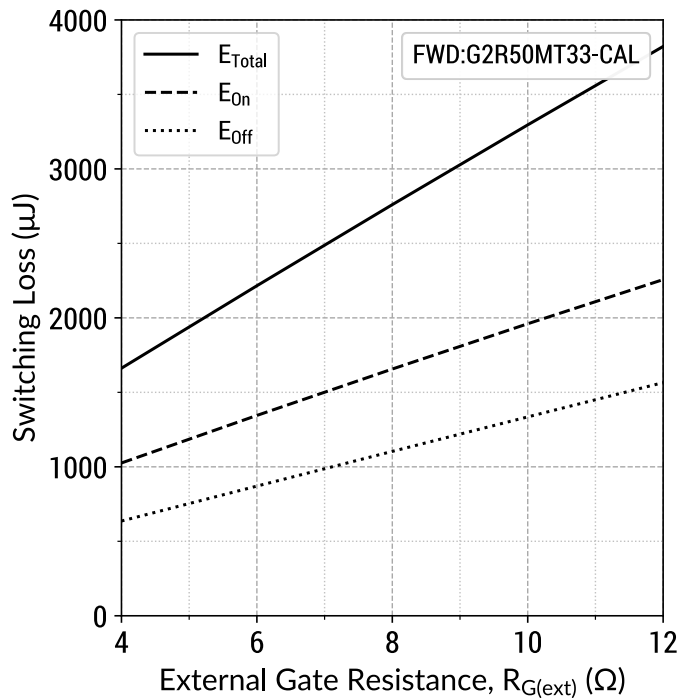

$T_j = 25^\circ C$; $V_{GS} = -5/+20V$; $I_{DS} = 50 A$

Figure 20: Switching Time v/s $R_{G(ext)}$
($V_{DD} = 1700V$)

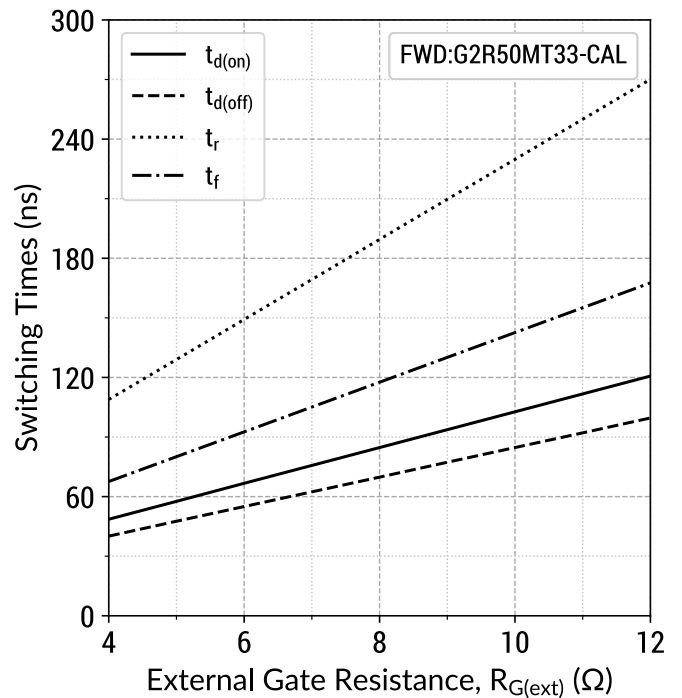

$T_j = 25^\circ C$; $V_{GS} = -5/+20V$; $I_{DS} = 50 A$

Figure 21: High Current IV

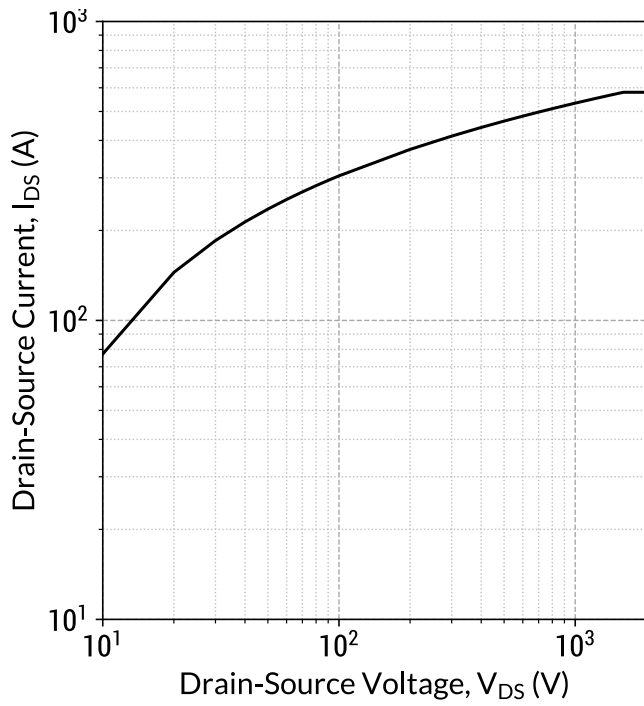

$I_D = f(V_{DS}); t_P \leq 3 \mu s; V_{GS} = 20 V$

Gate Charge Circuit

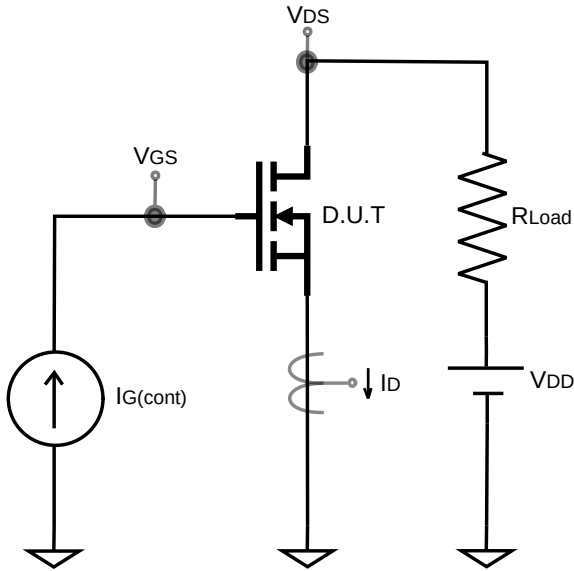

Gate Charge Waveform

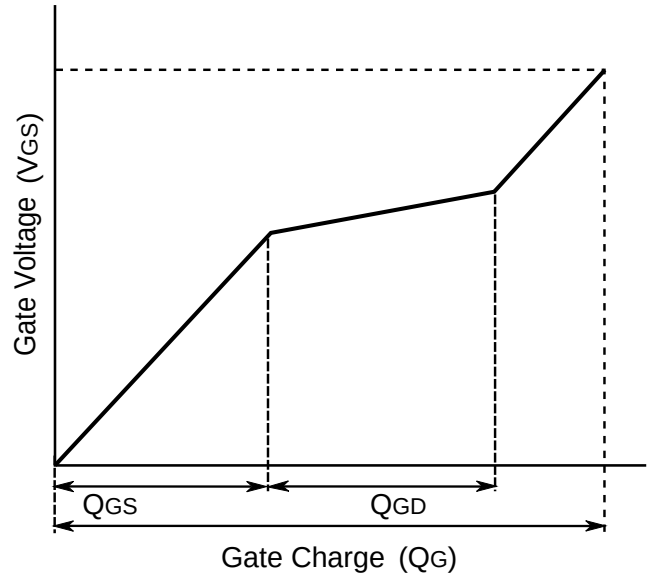

Switching Time Circuit

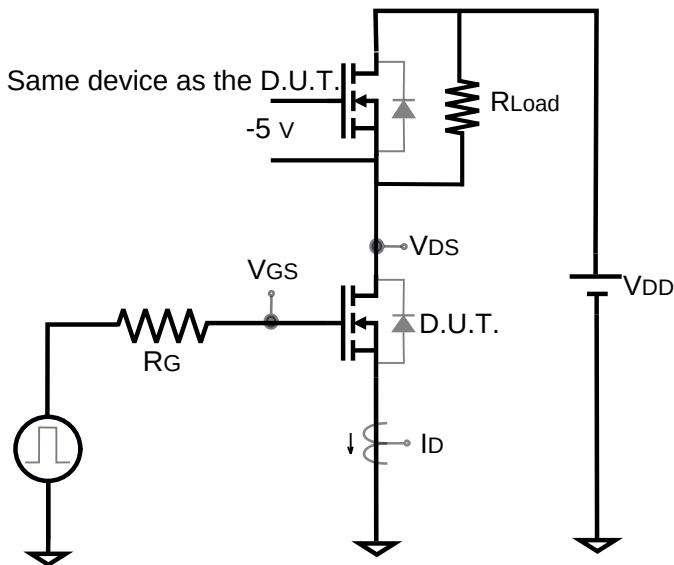

Switching Time Waveform

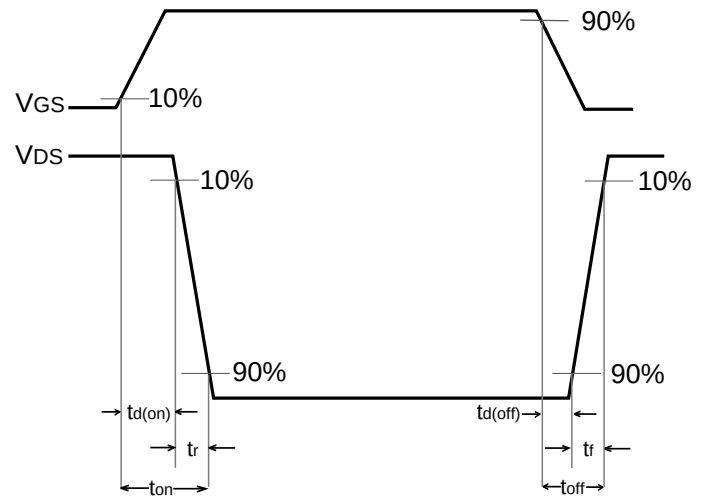

Switching Energy Circuit

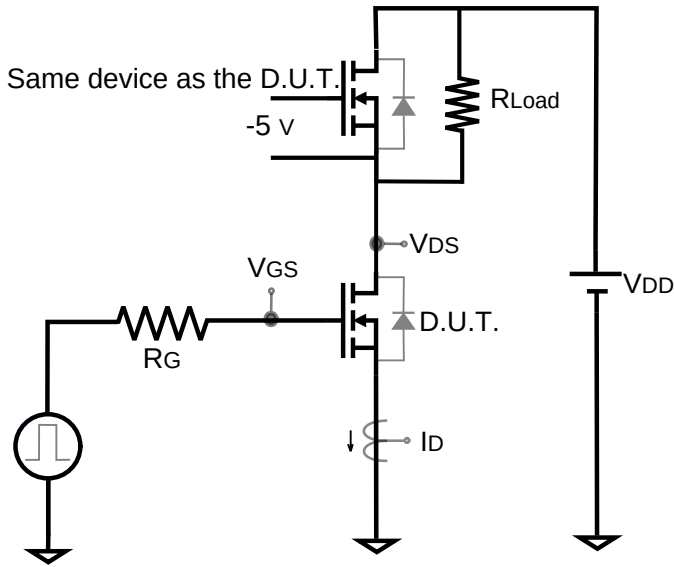

Switching Energy Waveform

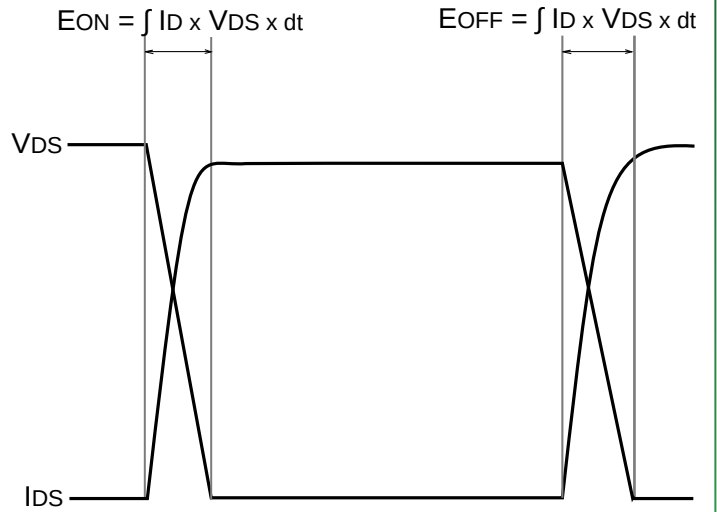

Reverse Recovery Circuit

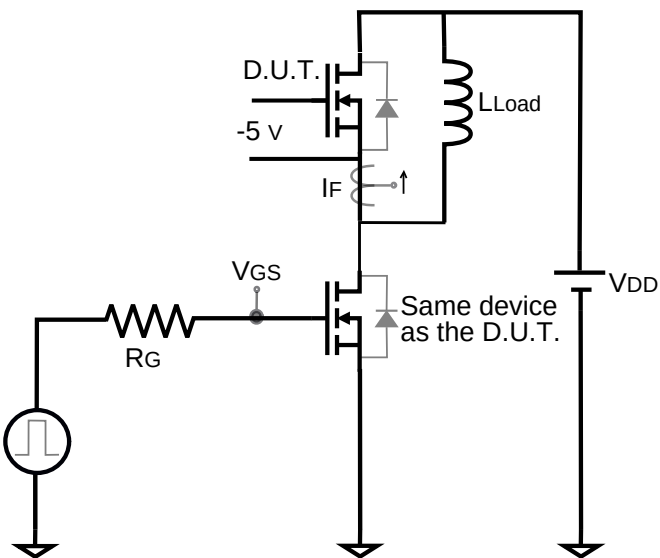

Reverse Recovery Waveform

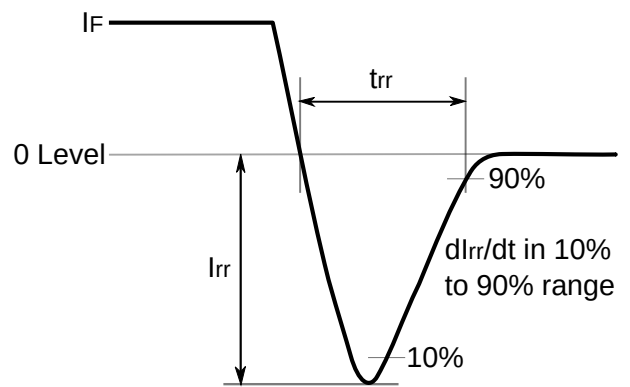

Mechanical Parameters

This information is **confidential**, please contact sales@genesicsemi.com to learn more.

Chip Dimensions

This information is **confidential**, please contact sales@genesicsemi.com to learn more.

NOTE

1. CONTROLLED DIMENSION IS MILLIMETER.
2. DIMENSIONS DO NOT INCLUDE END FLASH, MOLD FLASH, MATERIAL PROTRUSIONS.

Compliance

RoHS Compliance

The levels of RoHS restricted materials in this product are below the maximum concentration values (also referred to as the threshold limits) permitted for such substances, or are used in an exempted application, in accordance with EU Directive 2011/65/EC (RoHS 2), as adopted by EU member states on January 2, 2013 and amended on March 31, 2015 by EU Directive 2015/863. RoHS Declarations for this product can be obtained from your GeneSiC representative.

REACH Compliance

REACH substances of high concern (SVHCs) information is available for this product. Since the European Chemical Agency (ECHA) has published notice of their intent to frequently revise the SVHC listing for the foreseeable future, please contact a GeneSiC representative to insure you get the most up-to-date REACH SVHC Declaration. REACH banned substance information (REACH Article 67) is also available upon request.

Disclaimer

GeneSiC Semiconductor, Inc. reserves right to make changes to the product specifications and data in this document without notice. GeneSiC disclaims all and any warranty and liability arising out of use or application of any product. No license, express or implied to any intellectual property rights is granted by this document.

Unless otherwise expressly indicated, GeneSiC products are not designed, tested or authorized for use in life-saving, medical, aircraft navigation, communication, air traffic control and weapons systems, nor in applications where their failure may result in death, personal injury and/or property damage.

Related Links

- SPICE Models: https://www.genesicsemi.com/sic-mosfet/G2R50MT33-CAL/G2R50MT33-CAL_SPICE.zip
- PLECS Models: https://www.genesicsemi.com/sic-mosfet/G2R50MT33-CAL/G2R50MT33-CAL_PLECS.zip
- CAD Models: https://www.genesicsemi.com/sic-mosfet/G2R50MT33-CAL/G2R50MT33-CAL_3D.zip
- Gate Driver Reference: <https://www.genesicsemi.com/technical-support>
- Evaluation Boards: <https://www.genesicsemi.com/technical-support>
- Reliability: <https://www.genesicsemi.com/reliability>
- Compliance: <https://www.genesicsemi.com/compliance>
- Quality Manual: <https://www.genesicsemi.com/quality>

Revision History

- Rev 21/Feb: Added switching time and switching energy data
- Supersedes: Rev 20/Jun, Rev 20/Sep, Rev 20/Dec



www.genesicsemi.com/sic-mosfet/